

Sample board for USB DEVELOPPER KIT

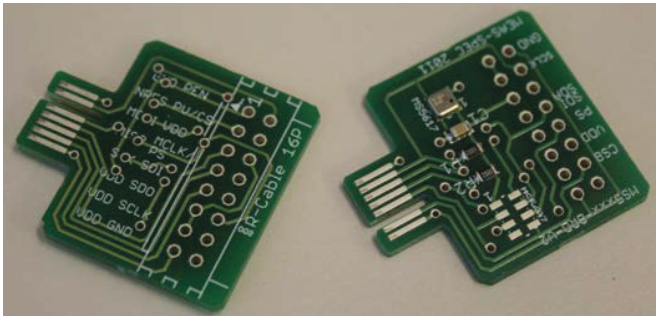

- Sample boards supporting several pressure modules including:
 - MS45xx family (on request only)
 - MS5536
 - MS5540 / 5541
 - MS5561
 - MS5607 / 5611
 - MS5637
 - MS5803
 - MS5805
 - MS5806
- 2 connectors on board:
 - USB Demo kit interface connector
 - 16 pins header user interface connector

DESCRIPTION

The MS5xxx-BRD is a sample board family which may be plugged into the “MEAS USB DEVEL KEY” tool. It currently supports all our sensors family like the MS45xx, MS55xx, MS56xx and MS58xx. Communication protocols 3wires/SPI and I2c are available on dedicated sample boards. All Samples Boards have a USBDEVEL KEY connector and also a standard 2x8 pins connector for user applications.

GENERAL BOARD DESCRIPTION

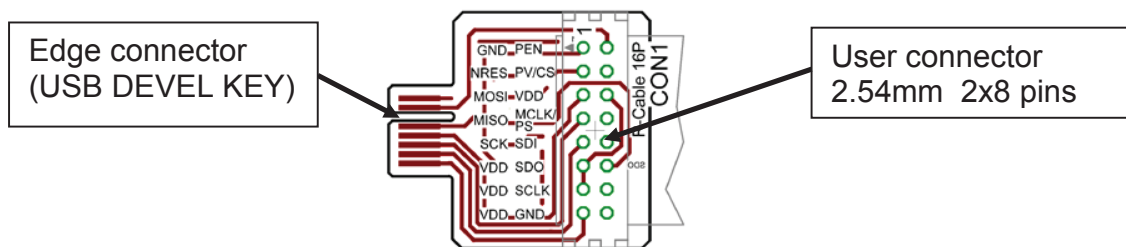

Figure 1 Top side view on Sample Board

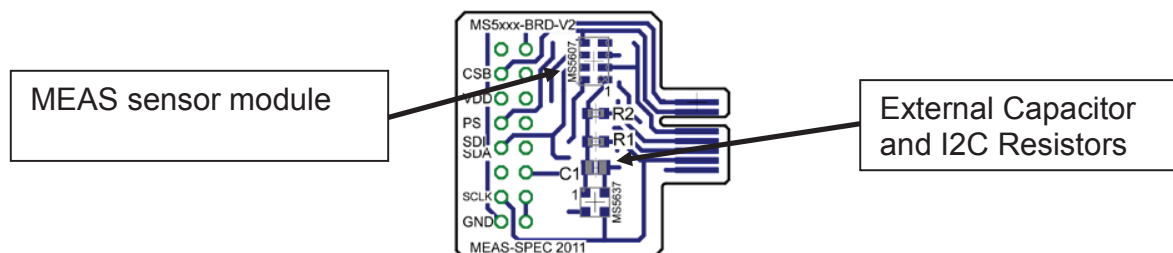

Figure 2 Bottom side view on Sample Board

Sample board for USB DEVELOPPER KIT

GENERAL BOARD SCHEMATIC DESCRIPTION

The "PCB for SAMPLES BOARDS" is done to be connected to the USB DEVEL KEY and also to a Header of 2x8 pin for customer use. We have SAMPLES BOARDS for all our products with dedicated communication bus.

SCHEMATIC FOR I2C BUS:

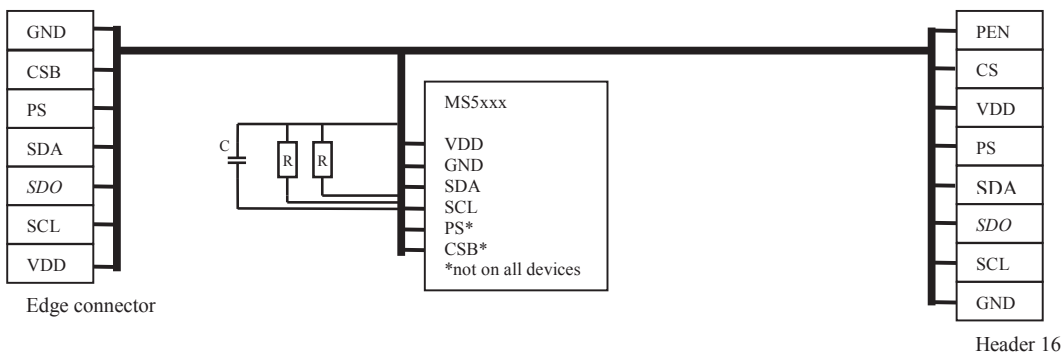

SCHEMATIC FOR SPI BUS:

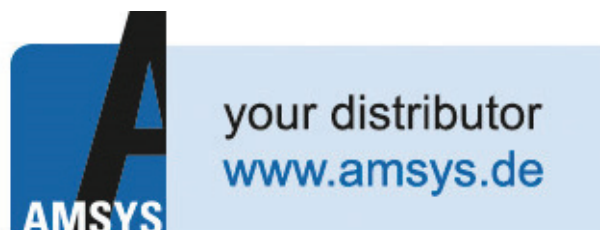
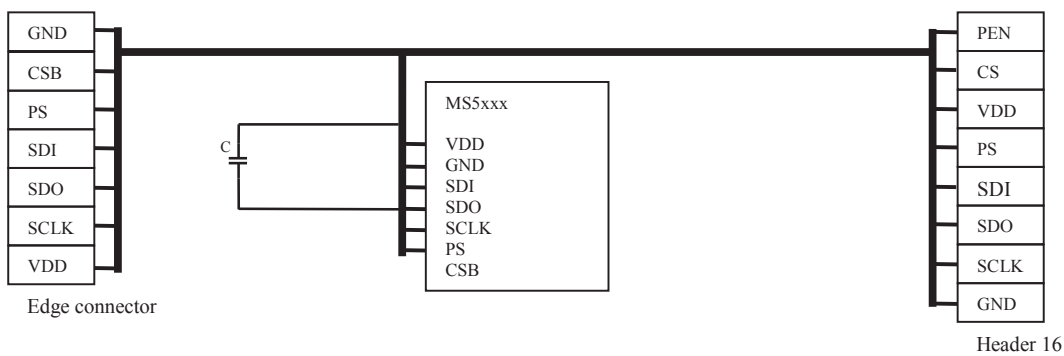

Sample board for USB DEVELOPPER KIT

BOARD PICTURES

Samples board with sensors



MS5536



MS5701
(replaced by MS45xx)



MS45xx

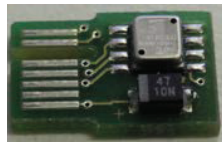

MS5561

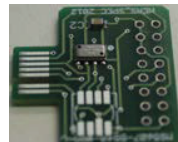

MS5607/MS5611

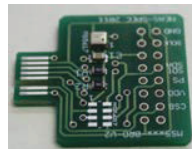

MS5637

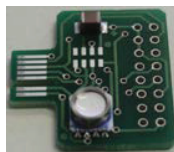

MS5540/MS5541

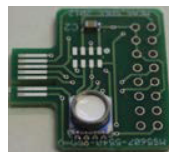

MS5803

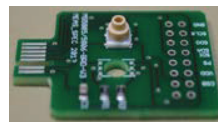

MS5805

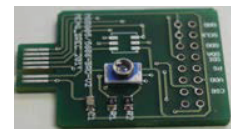

MS5806

Samples board for interfaces

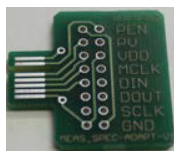

Internal connection

RECOMMENDED OPERATION CONDITIONS

Please refer to the sensor datasheet for all information.

Note: The total error is calculated to sum the different accuracy:

Total error = “Absolute accuracy”+”Maximum error with supply voltage”+”Long-term stability”

Sample board for USB DEVELOPPER KIT

HEADER 16 PINS INTERFACE PINOUT

The board also contains a complete 2.54 mm 2x8 PINOUT interface for signal monitoring or connection to a custom development board with a flat cable.

• Pin Name	• Pin	• Type	• Function
User interface			
PEN	2	I	Programming enable (1)
PV/CS	4	I	Negative programming voltage (1) / Chip Select
VDD	6	P	Positive supply voltage 3 volts from USB module*
MCLK/PS	8	I	Master clock (32.768 kHz) / Protocol select
SDI	10	I	Serial data input
SDO	12	O	Serial data output
SCLK	14	I	Serial data clock
GND	16	G	Ground

NOTE

- 1) Pin 4 (PV) and PIN 2 (PEN) are only used by the manufacturer for MS55xx test and should not be connected.

• Pin Name	• Pin	• Type	• Function
User interface			
GND	1	G	Ground
NRESET	3	I	Do not connect
MOSI	4	I/O	Do not connect
MISO	7	I/O	Do not connect
SCK	9	O	Do not connect
VDD	11	P	Positive supply voltage 3 volts from USB module*
VDD	13	P	Positive supply voltage 3 volts from USB module*
VDD	15	P	Positive supply voltage 3 volts from USB module*

Table 3: 2.54 mm 2x8 connector PINOUT

(*) Only if USB DEVL KEY is connected

Sample board for USB DEVELOPPER KIT

EDGE CONNECTOR PINOUT

The edge connector bottom side contains all the connections required for the different sensors using either the I2C, SPI or 3 wires protocol with the USB DEVEL KEY.

• Pin Name	• Pin	• Type	• Function
User interface			
GND	2	G	Ground
PV/CSB	4	N	Negative programming voltage (2) / Chip Select
MCLK/PS	6	I	Master clock (32.768 kHz) / Protocol select
DIN/SDI/SDA	8	I	Serial data input
SDO/-/DOUT	10	O	Serial data output
SCLK/SCL	12	I	Serial data clock
VDD	14	P	Positive supply voltage 3 volts from USB module
Manufacturer reserved interface			
GND	1	G	Ground
PEN	3	I	Programming enable (2)
NRESET	5	I	Reset input active low for microcontroller
MOSI	7	O/I	SPI output of microcontroller / external programming pin
MISO	9	I/O	SPI Input of microcontroller / external programming pin
SCK	11	O	SPI of microcontroller clock
VDD	13	P	Positive supply voltage 3 volts from USB module

Table 4: USB DEVEL KEY connector PINOUT

NOTE

2) Pin 3 (PV) and PIN 4 (PEN) are only used by the manufacturer for MS55xx test and should not be connected.



your distributor
 AMSYS GmbH & Co.KG
 An der Fahrt 4, 55124 Mainz, Germany
 Tel. +49 (0) 6131 469 875 0
 info@amsys.de | www.amsys.de

Sample board for USB DEVELOPPER KIT

MOUNTING AND ASSEMBLY CONSIDERATIONS

SOLDERING

Please refer to the application note AN808 & AN809 available on our website for all soldering issues.

MOUNTING

The sensors can be placed with automatic Pick & Place equipment using vacuum nozzles. They will not be damaged by the vacuum. Due to the low stress assembly the sensor does not show pressure hysteresis effects. It is important to solder all contact pads.

CONNECTION TO PCB

The package outline of the module allows the use of a flexible PCB for interconnection. This can be important for applications in watches and other special devices.

SEALING WITH O-RINGS

In products like outdoor watches the electronics must be protected against direct water or humidity. For those products the metal ring provides the possibility to seal with an O-ring. The metal ring is made of special anticorrosive stainless steel with a polished surface. In addition to this the ring is filled with silicone gel covering the sensor and the bonding wires. The O-ring (or O-rings) shall be placed at the outer diameter of the metal cap. This method avoids mechanical stress because the sensor can move in vertical direction.

CLEANING

MEAS sensors have been manufactured under clean room conditions. It is therefore recommended to assemble the sensor under class 10'000 or better conditions. Should this not be possible, it is recommended to protect the sensor opening during assembly from entering particles and dust. To avoid cleaning of the PCB, solder paste of type "no-clean" shall be used. Cleaning might damage the sensor!

ESD PRECAUTIONS

The electrical contact pads are protected against ESD up to 2 kV HBM (human body model). It is therefore essential to ground machines and personnel properly during assembly and handling of the device. MEAS Sensors are shipped in antistatic transport boxes. Any test adapters or production transport boxes used during the assembly of the sensor shall be of an equivalent antistatic material.

DECOUPLING CAPACITOR

Particular care must be taken when connecting the device to the power supply. A 100nF ceramic capacitor or a 47µF ceramic capacitor for the MS55xx series is implemented on the PCB. This capacitor will stabilize the power supply during data conversion and thus, provide the highest possible accuracy.

PULL-UP RESISTORS

Two pull up resistors are implemented on the PCB compatible with I2c bus. These resistors don't affect the use with the SPI bus.

Sample board for USB DEVELOPPER KIT

ORDERING INFORMATION

Product	Part Number / Art. Number
Samples board MS5536-60CPJU	PROTO-5536-60-BRD
Samples board MS5536-CNJU	PROTO-5536-CN-BRD
Samples board MS5540-CM	PROTO-5540-CM-BRD
Samples board MS5541-14BA-CM	PROTO-5541-14-BRD
Samples board MS5541-30BA-CM	PROTO-5541-30-BRD
Samples board MS5561-C	PROTO-5561-C-BRD
Samples board MS5607-02BA03	PROTO-5607-02-BRD
Samples board MS5611-01BA03	PROTO-5611-01-BRD
Samples board MS5637-02BA03	PROTO-5637-02-BRD
Samples board MS5803-01BA01	PROTO-5803-01-BRD
Samples board MS5803-02BA01	PROTO-5803-02-BRD
Samples board MS5803-05BA01	PROTO-5803-05-BRD
Samples board MS5803-14BA01	PROTO-5803-14-BRD
Samples board MS5803-30BA01	PROTO-5803-30-BRD
Samples board MS5805-02BA01	PROTO-5805-02-BRD
Samples board MS5806-02BA52	PROTO-5806-02-BRD
Samples board MS45xx	On request only
PCB DEVEL Internal Connection	PROTO-PCBDEVELBRD
USB DEVELOPMENT KIT	PROTO-USBDEVELKIT

FACTORY CONTACTS

NORTH AMERICA

Measurement Specialties
45738 Northport Loop West
Fremont, CA 94538

Tel: +1 800 767 1888
Fax: +1 510 498 1578
e-mail: pfg.cs.amer.ch@meas-spec.com
Website: www.meas-spec.com

EUROPE

MEAS Switzerland SA
Ch. Chapons-des-Prés 11
CH-2022 Bevaix

Tel: +41 32 847 9550
Fax: +41 32 847 9569
e-mail: sales.ch@meas-spec.com
Website: www.meas-spec.com

ASIA

Measurement Specialties (China), Ltd.
No. 26 Langshan Road
Shenzhen High-Tech Park (North)
Nanshan District, Shenzhen, 518107
China

Tel: +86 755 3330 5088
Fax: +86 755 3330 5099
e-mail: pfg.cs.asia@meas-spec.com
Website: www.meas-spec.com

The information in this sheet has been carefully reviewed and is believed to be accurate; however, no responsibility is assumed for inaccuracies. Furthermore, this information does not convey to the purchaser of such devices any license under the patent rights to the manufacturer. Measurement Specialties, Inc. reserves the right to make changes without further notice to any product herein. Measurement Specialties, Inc. makes no warranty, representation or guarantee regarding the suitability of its product for any particular purpose, nor does Measurement Specialties, Inc. assume any liability arising out of the application or use of any product or circuit and specifically disclaims any and all liability, including without limitation consequential or incidental damages. Typical parameters can and do vary in different applications. All operating parameters must be validated for each customer application by customer's technical experts. Measurement Specialties, Inc. does not convey any license under its patent rights nor the rights of others.